

Erection and Installation of Stainless Steel Components



Euro Inox

Euro Inox is the European market development association for stainless steel.

Members of Euro Inox include:

- European stainless steel producers
- national stainless steel development associations
- development associations of the alloying element industries.

The prime objectives of Euro Inox are to create awareness of the unique properties of stainless steel and to further its use in existing applications and in new markets. To achieve these objectives, Euro Inox organises conferences and seminars, issues guidance in printed and electronic form to enable architects, designers, specifiers, fabricators and end users to become more familiar with the material. Euro Inox also supports technical and market research.

Copyright notice

This work is subject to copyright. Euro Inox reserves all rights of translation in any language, reprinting, re-use of illustrations, recitations and broadcasting. No part of this publication may be reproduced, stored in a retrieval system, or transmitted in any form or by any means, electronic, mechanical, photocopying, recording or otherwise, without the prior written permission of the copyright owner, Euro-Inox, Luxembourg. Violations may be subject to legal proceeding and liable for monetary damages per infringement as well as cost and legal fees and fall under prosecution act of the Luxemburg copyright law and regulations within the European Union.

ISBN 2-87997-143-8

Full members

Acerinox

www.acerinox.es

Outokumpu

www.outokumpu.com

ThyssenKrupp Acciai Speciali Terni

www.acciaiterni.it

ThyssenKrupp Nirosta

www.nirosta.de

UGINE & ALZ Belgium

UGINE & ALZ France

Groupe Arcelor

www.ugine-alz.com

Associate members

Acroni

www.acroni.si

British Stainless Steel Association (BSSA)

www.bssa.org.uk

Cedinox

www.cedinox.es

Centro Inox

www.centroinox.it

Informationsstelle Edelstahl Rostfrei

www.edelstahl-rostfrei.de

Institut de Développement de l'Inox (I.D.-Inox)

www.idinox.com

International Chromium Development Association (ICDA)

www.icdachromium.com

International Molybdenum Association (IMOA)

www.imoa.info

Nickel Institute

www.nickelinstitute.org

Polska Unia Dystrybutorów Stali (PUDS)

www.puds.com.pl

SWISSINOX

Informationsstelle für nichtrostende Stähle

www.swissinox.ch

Erection and Installation of Stainless Steel Components
 First Edition 2006
 (Building Series, Volume 10)
 © Euro Inox 2006

Publisher

Euro Inox
 Registered office:
 241 route d'Arlon
 1150 Luxembourg, Grand Duchy of Luxembourg
 Phone: +352 26 10 30 50 / Fax: + 352 26 10 30 51
 Executive office:
 Diamant Building, Bd. A. Reyers 80
 1030 Brussels, Belgium
 Tel.: +32 2 706 82 67 / Fax: +32 2 706 82 69
 E-mail: info@euro-inox.org
 Internet: www.euro-inox.org

Author

Nancy Baddoo, The Steel Construction Institute,
 Ascot, UK



Disclaimer

Euro Inox and The Steel Construction Institute have made every effort to ensure that the information presented in this document is technically correct. However, the reader is advised that the material contained herein is for general information purposes only. Euro Inox, its members, specifically disclaim any liability or responsibility for loss, damage, or injury, resulting from the use of the information contained in this publication.

Contents

1	Introduction	2
2	Site conditions	3
3	Erection planning	4
3.1	General	4
3.2	Erection method statement	4
3.3	Trial erection	4
4	Supports, anchors and bearings	5
5	Erection drawings	6
6	Tolerances	6
7	Transportation, handling and storage	7
7.1	General	7
7.2	Transportation	7
7.3	Handling	7
7.4	Storage	9
7.5	Marking	11
8	Erection methods	12
9	Site welding	13
10	Surface protection	13
11	Cleaning before handover	15
12	Dissimilar metal contact	17
13	Cladding installation	20
13.1	Surface consistency	20
13.2	Flatness	20
13.3	Cleanliness	21
14	Fasteners	22
15	References	

Photo credits

Cedinox, Madrid (E), p. 23
 Centro Inox, Milan (I) p. 19
 Niton, Billerica, MA (USA) , p. 10
 NTD, Concorezzo (I), p. 10
 T. Pauly, Brussels (B), cover, p. 2, 6, 13, 14, 20, 21, 23
 V. Røyttä, Tornio (FIN) , p. 8
 Stelos Oy, Helsinki (FIN), p. 4, 12
 The Steel Construction Institute, Ascot (UK) p. 18
 Ugine & ALZ Belgium, Genk (B) p. 20
 B. Van Hecke, Brussels (B), p. 9, 11, 14, 15, 16

1 Introduction

Stainless steel is generally selected as a construction material because of its superior corrosion resistance or attractive surface finish in combination with an excellent strength to weight ratio [1,2].

This information leaflet outlines good site practice for erecting or installing both architectural and structural stainless steel components. Austenitic stainless steels are almost always the preferred grades for these applications; however the guidance is also applicable to ferritic and duplex stainless steels. This leaflet amplifies and explains the mandatory requirements on erection in the forthcoming European standard EN 1090 which covers the execution of steel structures [3, 4, 5].

Stainless steel structures can be constructed on site using welded joints, bolted connections or other special mechanical fastening methods.

The erection procedure for stainless steel components needs to be planned in writing, paying particular attention to:

- the properties of the material and the implications for erection,
- the conditions on the site,
- requirements for special tools or equipment,
- the possible need for trial installation,
- the stages of erection in relation to other construction work,
- the weight of parts, suitable lifting points and any requirement for auxiliary temporary supports or braces.

It is essential to maintain the corrosion resistance of stainless steel at each stage of the construction process. As finished stainless steel structures are not usually painted or treated in any other way, it is also important that the surface appearance is not changed or damaged during the manufacturing, fabrication, transportation or erection processes.



A unique combination of corrosion resistance, high strength and visual appeal make stainless steel an ideal material for exposed structures.

2 *Site conditions*

Erection should only start when the construction site meets certain safety requirements. Relevant issues which need to be considered include:

- adequate access to the site and within the site,
- provision and maintenance of hard standing for cranes and access equipment,
- limitations on dimensions or weights of components that can be delivered onto the site,
- details of adjacent structures which may affect the erection process.

3 *Erection planning*

3.1 **General**

The principal safety objectives when erecting steelwork are:

- stability of the part-erected structure;
- safe lifting and placing of steel components; and
- safe access and working positions.

The particular differences that arise when erecting or installing stainless steel components are:

- the greater relative flexibility of stainless steel components (especially architectural panels) that may have an effect on the stiffness of the part-erected structure;
- the need to ensure that components with architecturally-important finishes are not damaged during lifting and placing; and
- the need to provide safe access and working positions for suitably-timed site activities that do not generally occur unless there are requirements for architectural appearance (e.g. polishing and cleaning).

The principal means for ensuring that these specialist issues are properly addressed is to select contractors and site operatives who have experience of and training in the erection and installation of stainless steel components. Only by using suitably competent persons can safety and performance be assured.

In addition, the particular requirements of the project will need to be specifically addressed, both in preparing the erection method statement (see below), and in the briefing of the site team.

Full briefing of the site team on a regular basis, using the method statement, will ensure that they...

- understand what has to be done
- are provided with the necessary tools and equipment; and
- are given suitable methods and personal protective equipment to deal with safety hazards (such as the likelihood of sharp cut edges).

It is common for all activities associated with structural steel erection to be undertaken in one continuous site visit, and for an exclusion zone to be used to isolate the structural activity in the interests of safety.

However, this is often not possible when stainless steel components are being erected or installed, because finishing activities need to be undertaken much later than structural activities. Hence, it is likely that stainless steel activities will overlap with other site activities, and special attention will need to be paid to the implications of this for safe working and protecting previously-installed components.

3.2 Erection method statement

Prior to the start of site activities, an erection method statement needs to be prepared and agreed by the parties involved. This is a very important document which describes the procedures to be followed to erect a structure safely, economically and in a timely manner. Typical issues covered in the erection method statement are:

- position and types of site connections or joints,
- maximum piece size, weight and location,
- sequence of erection,
- methods of providing safe access to positions of work and safe working positions,
- permitted deviations for tolerances,
- experience from any trial erection.

It is essential that the erection method statement is consistent with the design assumptions. To ensure the resistance of the partly erected structure is sufficient to withstand the loads imposed during erection, the method statement must consider the stability of the part-erected structure. PrEN 1991-1-6 covers loading during execution [6]. Any requirements for temporary bracing or propping and features which would create a safety hazard during construction should also be considered.



Based on an explicit erection method statement, stainless steel structures can be erected safely and within a minimum of time

3.3 Trial erection

For expensive components that are difficult to replace at short notice and may be relatively easily damaged, it is more necessary than normal to ensure that site activities will take place exactly as planned. In such circumstances, the use of full or partial trial erection may offer the following benefits:

- the ability to inspect assembled units for acceptability
- the ability to check the sequence of erection proposed for safety (particularly if there are concerns about stability or access provision)
- the possibility of measuring the duration of operations (relevant if site conditions are restricted by limited possession time).

Experience from trial erection can then be fed back to improve the erection method statement. Trials can also be used to check transportation, handling and storage methods to pre-empt the possibility of damage occurring in transit.

4 *Supports, anchors and bearings*

The conditions, location and level of the supports for the steelwork should be suitably prepared to receive the stainless steel components. Erection should not begin until the location and levels of the supports, anchors or bearings comply with the acceptance criteria agreed or specified.

Shims and other supporting devices used as temporary supports under base plates should present a flat surface to the steel-

work and be of adequate size, strength and rigidity to avoid local crushing of the concrete. If packings are left in position after grouting they need to be made from materials with the same durability as the structure. Note that grouting materials in contact with stainless steel should not contain chlorides.

5 Erection drawings

Erection drawings should show all necessary details concerning the fixing of steel or bolts to the foundations, methods of adjustment, the fixing of stainless steelwork and bearings to their supports and welding, if used during erection. They should also show details and arrangements of any steelwork or other temporary works necessary for erection purposes to ensure the stability of the construction or the safety of personnel.

For cold formed members and sheeting, installation drawings are necessary to convey information such as the type of fasteners and washers and sequence of fastenings including special installation notes for the type of fasteners (e.g. drilled hole diameter and minimum torque). Information such as seam and sidelap joints and the location of expansion joints should also be included.

6 Tolerances

Stainless steel is usually used in an exposed manner for architectural reasons. This implies that slacker tolerances for carbon steel which can be overcome by shims or a little forced fit may not be so acceptable in many stainless applications. Therefore,

tighter tolerances may be needed for stainless steel structures. PrEN 1090-2 [4] contains tables of erection tolerances given as permitted deviations for the nodal positions and straightness/flatness of erected components. These are divided into two classes. Whilst both classes should meet the dimensional criteria necessary for stability of the structure, the tighter tolerance class may be specified if more accurate fit-up is required for other reasons.

The thermal expansion of austenitic stainless steels is approximately 50% more than that for carbon steel [7]. Due consideration should be given to the thermal expansion of large stainless steel structures both in specifying erection tolerances and in checking them on frame completion.



As stainless steel structures are usually visible and the visual surface quality is important, tight tolerances have to be respected.

7 *Transportation, handling and storage*

7.1 General

Stainless steel components should be accompanied by accurate instructions for storage, handling and installation in order to maintain the surface quality. This is particularly important for bright annealed, polished, textured and coloured or painted finishes. At all stages of fabrication, transportation, handling, storage on site and erection, it is necessary to avoid contamination of the surface of stainless steel components by carbon steel and iron. This is to prevent carbon steel pick-up, which may subsequently rust and stain the surface.

Measures must be taken to prevent such contamination due to contact with carbon steel. Also, if work of a fabrication nature needs to be undertaken on site, it will be necessary to use quarantined work areas, tools which are dedicated only to stainless steel, and stainless steel wire brushes or wool, and to avoid using carbon steel lifting tackle and unprotected forks of fork lift trucks. Other potentially harmful contaminants include oils, greases and weld spatter.

The use of strippable plastic film coatings on the stainless steels can help to avoid surface contamination (Section 10). If the stainless steel has a protective film, it should be left on as long as practicable and removed just before handover [8].

7.2 Transportation

Special packaging measures may be needed for protecting stainless steel components in transit in order to protect the sur-

face. For example, care is needed when components are being secured to pallets or vehicles for transport to avoid damage to surfaces from straps or strapping. Suitable protective materials should be placed between the stainless steel and the securing straps. If carbon steel strapping is to be used to secure items to pallets or in bundles, some form of wrapping or padding is required to prevent the strapping from damaging the edges or surface of the stainless steel components.

Corrosion damage may occur if moisture condenses on surfaces under plastic packaging (particularly heat shrink wrappings) during transport. This is more likely to happen if the packaging remains in place for a long time and if the conditions are humid, especially if an item is to be shipped in a humid or salt-laden environment. Suitable desiccants packed within the packaging can help alleviate the moisture problem. After delivery the stainless steel should be inspected to identify any surface defects that require correction.

7.3 Handling

Stainless steel components should be handled and stacked in such a way that the likelihood of damage is minimized. Care is necessary during all handling and lifting operations to ensure that the stainless steel is not mechanically damaged. If chain slings are used, these inevitably tend to slip, causing mechanical damage of the surface. Slings of heavy duty synthetic material are preferable and may reduce the risk of cross-contamination.

Steel components damaged during off-loading, transportation, storage or erection need to be restored to conformity. For stainless steel components, it may prove difficult to undertake the specialist correction work necessary on site, thus necessitating the return of the damaged component to the fabrication works, or even its replacement. Hence, the emphasis is on using sound handling methods to minimise the likelihood of damage in transit.

Plastic slings on the lifting gear and film protection of the stainless steel components prevent ferrous contamination and mechanical damage



Thin gauge cold formed components and sheeting may be particularly prone to edge damage, twisting or distortion if handled as individual items. Hence they are often best packaged into bundles for transit, as nested components are likely to be more robust. However, care should be taken to avoid localized damage to unstiffened edges at lifting points or other zones where the total weight of the bundle is imposed on a single unreinforced edge.

Completed stainless steel members are likely to be slender increasing the likelihood of localised damage from single point lifting of long components. As is commonplace with comparable carbon steel structures, consideration should be given to the use of spreader beams and additional tem-

porary stiffening devices to maintain individual member stability during lifting. Sleeved slings will assist, but dedicated lifting points integrated into the structure are a better solution.

All handling equipment should be cleaned shortly prior to its use with stainless steel components. It is therefore advisable to plan and schedule the handling of stainless steel components because, if handling equipment is used on an uncontrolled basis, this cleaning is often neglected and contamination results.

Stainless steel should be protected from direct contact with carbon steel lifting tackle or handling equipment such as chains, hooks, strapping and rollers or the forks of fork lift trucks by the use of isolating materials such as light plywood or suction cups. These requirements should be developed into work instructions for site lifting operations that can be appended to the erection method statement, and used to brief the site team.

Contact with chemicals, including dyes, glues, adhesive tape, undue amounts of oil and grease should be avoided. If it is necessary to use them, their suitability should be either checked with their manufacturer, or tested by applying them to a trial piece of equivalent stainless steel.

There can be certain health hazards in lifting stainless steel components in that the cut edges may be rather sharp. If this hazard cannot be avoided by protecting the cut edges, it should be identified when the erection and handling methods are developed and suitable protective equipment issued to site personnel.

7.4 Storage

Stainless steel components need to be stored suitably carefully, so that the surfaces are protected from damage or contamination. Dry storage under cover is preferable, particularly if a wrapping which might absorb water and stain the surface, such as cardboard, has been used. It is preferable for planar-shaped components made from sheet or plate to be stored upright in racks. If storage racks are used, they should be protected by wooden, rubber or plastic battens or sheaths to avoid carbon steel, copper-containing or lead rubbing surfaces.

Long periods in salt-laden or other aggressive environment can seriously impair the passive film on lower grade



Assemblies need to be protected to avoid damage and contamination pick-up during storage, handling and transport



The plastic packaging protects the stainless steel hollow sections against iron pickup from carbon steel racks.

stainless alloys such as grade 1.4301 (304). Hence, a limitation should be set for the storage period in such atmospheres for lower grade alloys.

Fasteners stored on site should be kept in dry conditions, suitably packed and identifiable.

The storage areas should be secure against theft as stainless steel is a valuable material and can be costly to repair or replace.

The table overleaf describes four indicators which can be used to distinguish between stainless steel and other metals on site. Chemical and electrochemical test kits can be used for distinguishing between molybdenum-containing grades like 1.4401 and non-molybdenum-containing grades like 1.4301. Also hand-held X-ray devices are available, which analyse the chemical composition of metallic materials.

Distinguishing between stainless steel and other metals on site

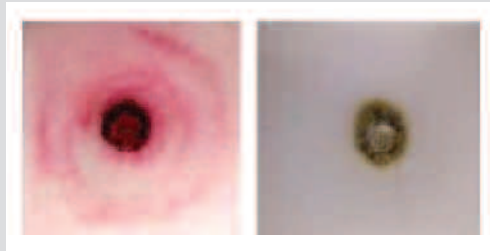

To distinguish molybdenum-containing grades such as 1.4401 or 1.4404 (left) from their non-Mo-containing counterparts 1.4301 or 1.4307 (right), test liquids are available.

Colour

Stainless steel and carbon steel can be of similar colour, for example when freshly machined, cut or abraded and, in such conditions, are difficult for the untrained eye to tell apart.

Density

There is very little difference between the densities of stainless steels and carbon steels. Aluminium alloys are about one third the density of steels.

Magnetism

Ferritic and duplex grades of stainless steel are magnetic. Austenitic grades of stainless steel in the annealed (softened) state are not magnetic, though they have a tendency to exhibit some magnetic properties when they are cold worked. The partial magnetic attraction exhibited by components with complex shapes is usually non-uniform, and is more marked at formed corners or near drilled holes or machined faces. This uneven distribution is often useful in confirming the steel as an austenitic type because this variation in attraction to a magnet does not occur with other stainless steels, carbon steels or metals like aluminium.

Corrosion resistance

A large drop of tap water left on a steel surface overnight will normally produce rust staining on a carbon or low alloy steel, but not on stainless steel.



Easy-to-use electro-chemical test methods are available to find out whether a stainless steel grade is molybdenum-containing (left) or not (right).



For a complete analysis of the alloy, special hand-held devices are available, which indicate its chemical composition.



7.5 Marking

Typically, the rolling or polishing direction is indicated on the strippable plastic film. Care has to be taken that all visible components are fabricated and installed in such a way that the rolling and polishing direction is maintained throughout.

All components to be assembled or erected at the site will be allocated an erection mark, which may be the same mark for identical components in a batch. A component should be marked with its erected orientation if this is not clear from its shape. Markers containing chloride or sulphide should not be used.

Marks should be placed, if possible, in positions where they will be visible in storage and after erection. Marks applied to the adhesive film protecting a stainless steel component will be lost after removal

of the film. Provided that a check is made that components have been properly installed in their planned locations, it is possible then to rely on annotated drawings to trace erected components.

Special provisions may be needed if the placing of the mark would be detrimental to the finished appearance. Note that marks applied to an adhesive film may result in a read-through or stencil effect on the stainless steel surface. It is therefore advisable to carry out a test on an offcut piece or seek advice from the coatings manufacturer.



Strippable plastic film typically indicates the rolling direction.

8 Erection methods

The erection of the steelwork should be carried out in accordance with the erection method statement, ensuring stability at all times.

Stainless steel structures generally require no special erection techniques provided care has been taken in the fabrication process to ensure that the members are straight and free from excessive weld distortion at the connection (otherwise site fit-up problems will arise with attendant expensive site-correction costs). Throughout the erection of the structure, the steelwork should be made safe against temporary erection loads, including those due to erection equipment or its operation and against the effects of wind loads on the unfinished structure.

All temporary bracing and temporary restraints should be left in position until erection is sufficiently advanced to allow their safe removal.

Each part of the structure should be aligned as soon as practicable after it has been erected, and final assembly completed as soon as possible after that. Permanent connections should not be made between components until a sufficient part of the structure has been aligned, levelled, plumbed and temporarily connected to ensure that components will not be displaced during subsequent erection or alignment of the remainder of the structure.

Alignment of the structure and lack of fit in connections may be adjusted by the use of shims. Shims should be secured where they are in danger of coming loose. For stainless steel structures, shims should be made of stainless steel. They should have similar durability to that of the structure and be of a minimum thickness of 2 mm if used in an external environment. If shims are used to align structures composed of coated material, the shims should be protected in a similar manner to provide the specified durability.

The erection techniques used for stainless steel structures are essentially the same as those for carbon steel structures



9 Site welding

If site welding is required, specific weld procedures should be followed. PrEN 1090-2 gives comprehensive guidance on welding, including a list of all relevant European welding standards. EN 1011-3 [9] gives much useful information about arc welding of stainless steels.

Stainless steel can be welded to carbon steel providing certain weld techniques, processes and consumables are used (see also Section 12) [10]. In all cases a welding procedure specification should be prepared



On-site welding of a stainless steel swimming pool structure

as the basis of work instructions and this should be based on a welding procedure qualification record as appropriate.

10 Surface protection

Surface protection may be specified to protect the surface from superficial damage and prevent contamination during fabrication, transportation, on-site storage and erection. Surface protection will minimize and sometimes completely eliminate the need for cleaning before handover.

Components, for which appearance is unimportant, such as concealed structural applications, need minimal surface protection. Superficial damage is less critical and may not necessarily lower the resistance to atmospheric corrosion of the stainless steel. Contamination, particularly by carbon steel, will cause staining as the carbon steel particles rust. Unless the associated deterioration in appearance is of concern, little protection is required other than following general good practice.

For stainless steel components where appearance is crucial, such as curtain

walling and cladding panels, it is essential for the surface to be effectively protected. Unlike with carbon steel, surface defects cannot be disguised by a coat of paint. This is particularly important for textured, coloured or painted surfaces as on-site repair of defects is not usually possible. Properly planned work instructions in method statements are very important, and operatives must be competent with experience of handling and installing such components.

Surface protection usually takes the form of an adhesively applied plastic film. The plastic film needs to be easy to apply, effective and removable without leaving deposits on the surface. The film manufacturer's advice should be sought on the choice of film material, type of adhesive and the maximum time that can be allowed before removal of the film. Prolonged exposure to heat, sunlight

or pressure can make stripping the film difficult and cause adhesive to be retained on the stainless steel surface, leading to consequent cleaning problems. This becomes a greater concern if the building is located in a region of the world which experiences high levels of sunlight.

Film manufacturers give typical warranty periods of 6 months against both the deterioration of the glue and the plastic (spanning from production at the coating manufacturers to removal on site).



For exterior applications, the protective film should be of a UV resistant type, which remains intact and does not tear easily (left). Protective plastic film for interior use, which is exposed to sunlight for an extended period of time, can become difficult to strip leaving traces of adhesive on the stainless steel surfaces, which are time-consuming to remove (right).



It is generally advisable to specify the lowest level of adhesion possible to satisfy the project's requirements. If previous experience is not available to assist such decisions, trial specimens can be prepared and tested in simulated conditions.

If construction work is continuing around the finished stainless steel structure after the coating has been stripped off, consideration should be given to applying a new adhesive film in vulnerable areas until all adjacent construction work is complete.

There is a close relationship between film and adhesive type, adhesion level and film thickness. The following factors need to be considered when determining the most cost-effective combination:

- mechanical protection standards required to cater for the amount of handling and associated abrasion or impacts in the workshop, during transportation and on site
- protection against airborne and waterborne pollutants, such as alkaline concrete dust arising on site or acid rainfall
- requirement to withstand degradation by UV light during storage and after installation
- type of surface to be protected (the adhesion level required is related to the surface contact area and steel thickness)
- cost.

In special cases the likelihood of physical damage arising from other construction operations can be minimised by screening the location and designating an exclusion zone around it, perhaps with a permit to work procedure if other operations do have to take place within the zone.

Protective films may have been applied to the surface of the stainless steel to assist lubrication and protection during forming and fabrication. Films for use on architectural components must be suitable for remaining on the surface for an extended period of time without deteriorating upon exposure to external atmospheres and sunlight. In some cases, for example thicker or heavier components, a double layer of film may be applied to afford additional protection.

Localized removal of the film may be required to allow local welding, but these areas should be re-covered with patches of comparable film material, after cleaning. The film should be kept in place for as long as possible, total film removal preferably

only occurring just prior to handover to the client. By starting to strip the film at the top of the building and working down to the base, any dirt or debris falls onto the protected lower layers.

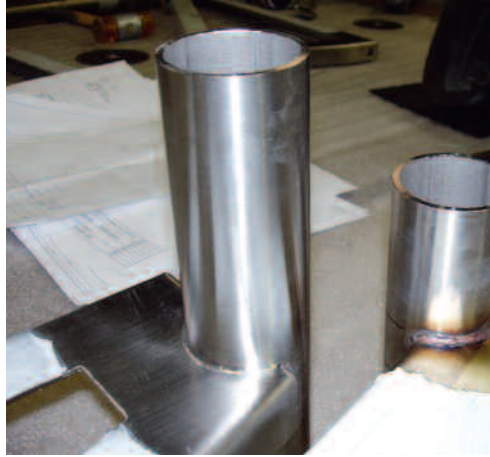

Strippable plastic film can be left on the surface during most forming and placing operations. For welding and subsequent finishing operations, it may be sufficient to remove it locally.

11 Cleaning before handover

If the stainless steel forms part of the ‘hidden’ structure, any cleaning, if required, will be minimal. However, deposits of dirt, or any contamination, should be still removed from the surface of the steel.

Stainless steel surfaces which have been protected by an adhesive film do not normally require cleaning.

If stainless steel surfaces have not been protected by an adhesive film or have been left exposed for a time after removal of the film, then they should generally be cleaned prior to handover in order to achieve maximum corrosion resistance and aesthetic appeal.

Different cleaning procedures are followed depending on the surface finish, corrosion risk and function of the component. These procedures should be set out in work instructions appended to the general erection method statement.

A typical procedure for cleaning cold rolled (2B) stainless steel is:

- Rinse with water to remove loose dirt.
- Wash with water containing soap, detergent or 5% ammonia, using a soft, long fibre brush if necessary.
- Rinse thoroughly with clean water.
- If required, remove with water with overlapping strokes, working from top to bottom.

Any cleaning materials or brushes used must not contain or produce chlorides.

When cleaning polished surface finishes, the cleaning movement should be in the same direction as the grain.

If iron contamination is suspected, it can be detected and removed on site; ASTM A380 [11] gives a suitable detection method. Embedded iron can be removed by either pickling or passivation. Both are carried out after degreasing (removing oil,

grease and other organic contamination).

Many of the cleaning techniques used for bare stainless steel should not be used on chemically coloured/painted stainless steel, as the colouring systems are more delicate than the steel surface. Specific advice should be sought from suppliers. Site repair of these finishes is not usually possible, and therefore the planning of handling and installation needs to be especially thorough to prevent damage arising.

The strong acid (chloride-based) solutions sometimes used to clean the masonry and tiling of buildings should not be permitted to come into contact with any metal, including stainless steel. If such contamination does happen, the acid solution must be washed off immediately with large amounts of water. If practical, operations should be sequenced so that any ceramic tile fixing and cleaning is completed before neigh-

bouring stainless steel components such as skirting boards or kick plates are installed. Otherwise, special measures will be needed to control run-off from wet trades taking place in areas adjacent to and above locations where stainless steel components are installed. Grouting of structural components made of stainless steel will bring alkaline products directly into contact with them, and the implications of this will need to be addressed.

Care must be taken to ensure that any cleaning materials or rinsing agents used do not adversely affect surrounding materials e.g. blockwork, other metals, insulation or caulking compounds [12, 13].



Localized rust staining was caused by iron particles from a disc, which had previously been used on carbon steel (left). If ferrous contamination has occurred, it can be removed by on-site pickling (right) [12]

12 Dissimilar metal contact

If dissimilar metals are in contact with moisture present, then there is a risk of bimetallic corrosion. To avoid this risk, direct contact between stainless steels and other metals and alloys should be avoided, if possible. If dissimilar metal contact cannot be avoided, then it is general good practice to provide insulation between the materials, although this is not always necessary in benign environments, and in some cases is impractical. As an alternative, it may be possible to circumvent the risk of corrosion by preventing the ingress of water that might otherwise act as the electrolyte.

The method adopted to avoid electrolytic contact or prevent ingress of water will depend on the detail in question and

should be agreed with the stainless steel supplier. However, these methods can be difficult to install reliably and require careful attention to detail. The figure overleaf shows an isolation detail at a bolted connection, accompanied by installation notes.

It is essential to use stainless steel fasteners for connecting stainless steel components (cf. box overleaf).

If stainless steel is to be welded to carbon steel, the corrosion protection applied to the carbon steel component or structure must continue over the cleaned weld zone and extend at least 20 mm onto the stainless steel, with the layers of a coated application suitably lapped over.

Bimetallic corrosion

If dissimilar metals are in a common electrolyte, then an electric current may flow from the less noble metal (the 'anode') to the more noble metal (the 'cathode'), and the less noble one will corrode away at a faster rate than would have occurred if the metals were not in contact. This is called bimetallic (galvanic) corrosion. Stainless steels generally form the cathode in a bimetallic couple and therefore it is usually the other metal in the couple which may suffer additional corrosion.

Typical electrolytes encountered in construction are rain or condensation. The rate of corrosion depends on the relative area of the metals in contact, the temperature and the composition of the electrolyte. The general behaviour of metals in bimetallic contact in rural, urban, industrial and coastal environments is documented e.g. in BS PD 6484 Commentary on corrosion at bimetallic contacts and its alleviation [14].

For mechanical connections in stainless steel structures, the corrosion resistance of

the fasteners should be at least equal to that of the stainless steel being joined. A widespread mistake is the use of non stainless fasteners e.g. galvanised screws or aluminium rivets, for fastening stainless steel components. The larger the area of the noble cathode in relation to that of the anode, the greater the rate of bimetallic corrosion attack. Consequently an adverse area ratio results when the noble stainless steel is joined with a much less noble material like aluminium rivets and this may result in rapid deterioration of the fasteners. Similarly, galvanised screws which would otherwise last for a decade can rust away very quickly if used to fasten stainless steel sheet. In addition, the rust resulting from this corrosion process can contaminate the stainless steel, create staining and may induce pitting corrosion. Therefore it is essential to use stainless steel fasteners for stainless steel components.

Note that bimetallic corrosion is rarely a concern when dissimilar grades of stainless steel are in contact.



Non-stainless steel fasteners in stainless steel panels suffer accelerated and severe corrosion.

Installation notes:

1. During assembly it is important to install the insulating materials as detailed and to avoid damaging them.
2. In general, the bolt assembly will be one of several in a connection joint. In that case the connection should be carefully aligned first using suitable metal drifts or podger spanners.
3. If the bolt assembly is used singly, the connection cannot be both aligned and held in position using a metal drift or podger spanner. In that case, some other means needs to be adopted to hold the connected parts in alignment whilst the single bolt is inserted. It is not acceptable to force the connection into alignment by driving home the bolt itself as this will damage the insulating bush around the bolt barrel.
4. Prior to bolt installation, the insulating gaskets at each bolt location will need to have been positioned already. This may require that the gaskets are secured in their positions by adhesive that will not damage the long term integrity of the gasket material.
5. After alignment, the holes in the plates to be attached should be checked to ensure that they are sufficiently well aligned not to damage the insulating bush around the barrel of each bolt as they are inserted.
6. The detail adopted should ensure that there is sufficient clearance between the bolt barrel itself and the internal diameter of the holes to accommodate the thickness of the insulating bush after allowing for adverse manufacturing tolerances and some residual lack of perfect alignment between the holes in the plates to be connected. This may be checked in a trial assembly of a typical connection in the works before commencement on site
7. Immediately after each bolt assembly is completed it should not be fully tightened until all bolts in the connection are in position. Then the bolts should be tightened in a controlled sequence starting from the centre of the bolt group and moving outwards.
8. Care needs to be taken not to over-tighten the bolts as this may result in the insulating gaskets and washers being squeezed and damaged. Control of the applied torque may necessitate the use of a calibrated wrench, or it may be possible to develop a careful procedure based on practice on a trial assembly using a suitably-sized spanner.
9. After assembly, or later after a period of use, it is possible to check the integrity of the insulation using an electrical resistance meter or megger. However, this only provides reliable results in truly dry conditions, and if there is no alternative electrical conduction path through other connected structural components.

Stainless steel washers and insulating bushes interrupt the galvanic couple and prevent bimetallic corrosion

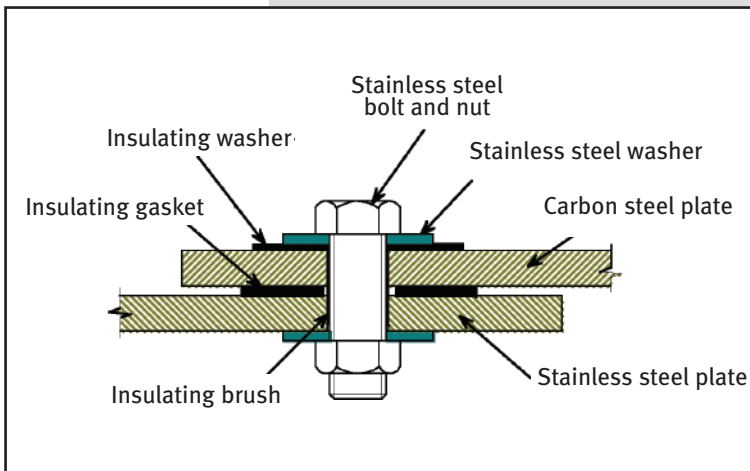

13 Cladding installation

13.1 Surface consistency

It is particularly important to ensure appropriate storage and handling procedures are followed for components made from thin gauge material because they are more vulnerable to damage.

Very slight changes to the processing route can result in subtle variations to the surface finish. For example, material polished by a new abrasive belt will appear slightly different to material polished by an older belt. It is therefore advisable to ensure that adjacent panels on the finished structure come from adjacent material in the process route. Components such as panels or cassettes should be specified and manufactured so that they can be installed to align consistently with the original rolling direction of the stainless steel constituent product, with the coil direction pointing either upwards or downwards but not both ways. Care should be taken therefore to ensure that the specification requires the product rolling mill to mark the rolling direction on the underside of the stainless steel sheet, both on the panel and the protective film (the latter is

usually ensured by the presence of pre-printed markings on the coating surface). Any panel installed in the reverse direction will reflect light differently under certain light conditions and will appear differently on the façade. This rule applies to plain, polished, textured and coloured finishes.

13.2 Flatness

Screwing stainless steel panels too tightly may lead to the panel becoming distorted. ‘Dimpling’ of the sheet at fastener positions can be avoided by

- increasing the thickness of the sheet
- placing reinforcing pads under the screw heads
- using hat channels on the inside of a stainless steel sheet (the nut is fastened to the hat channel so that the pull of the fastener is distributed over a large area of the metal face)
- stud welding: studs can be welded to stainless steels of most thicknesses, but some localized heat discolouring is inevitable. On thin sections, ‘telescop-

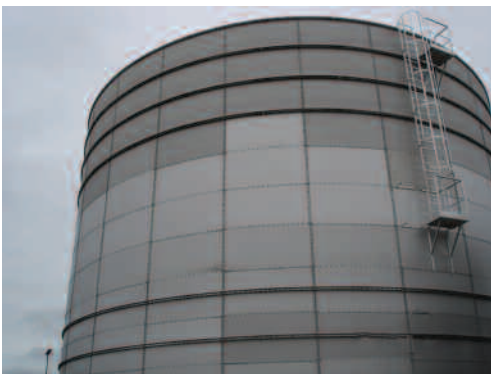

The combination of sheet metal from different batches may lead to inconsistency in visual appearance

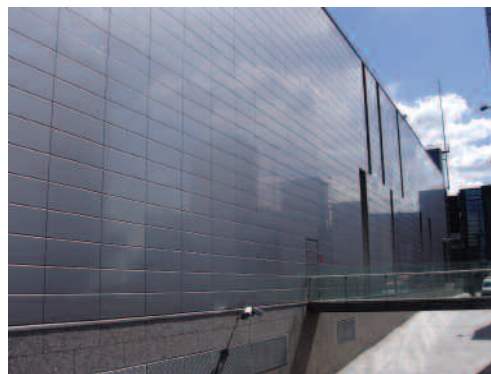

The use of stainless steel from the same supplier and from the same batch ensures consistency of the surfaces.



The stiffening effect of the edges ensures optical flatness

ing' or 'read-through' will be evident, particularly on highly reflective finishes. If it is important to minimise this, then material thickness should be increased and stud sizes and settings modified accordingly.

Light gauge reflective stainless panels used over broad areas can be susceptible to optical distortion or 'oil canning'. Architectural panel profiles with wide web or flat areas are particularly vulnerable. The brighter the surface finish, the more demanding will be the flatness requirement and the greater the susceptibility to oil canning. Oil canning can be caused by a number of factors, including poor incoming sheet flatness, cutting, forming, welding, handling and installation operations. During forming, compressive stresses can occur in the longitudinal direction of the panel and these can also result in elastic buckling of the sheet.

Oil canning can be avoided by

- using slightly concave panels to eliminate all flat reflective surfaces
- backing light gauge stainless sheet with a stiffer material
- using a panel with a shallow, die-pressed design

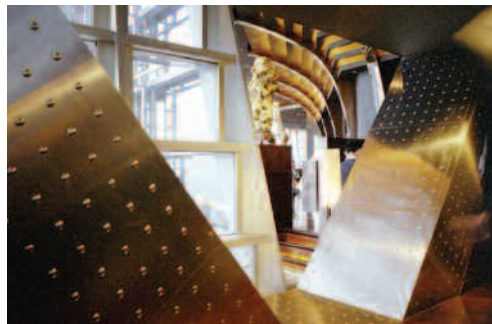

- breaking up the reflective surface by using textured stainless steel or by using a less reflective finish, or a combination of finishes
- specifying a relatively heavy gauge that will be less susceptible to buckling.

It is not always possible to detect oil canning if the stainless steel is protected by an adhesive film.

Austenitic stainless steel has lower heat conductivity and a higher thermal expansion than carbon steel, which can cause localized stresses, leading to buckling. It is therefore advisable not to make stainless steel panels too wide and to allow space for expansion. Large panels are often fixed with one close tolerance hole at a set point and slotted holes elsewhere.

13.3 Cleanliness

Thin gauge cold rolled material often has a superior finish. Clean linen gloves should be worn when handling such material to avoid finger marking. If marks occur, they can be removed by the use of a mild organic solvent followed by cleaning with a warm detergent solution. Sometimes a warm detergent solution will be sufficient. Thorough clean water rinsing and drying completes the removal process.

The use of embossed or otherwise structured panels reduces the risks of inconsistency in optical flatness

Checklist:**Successful communication between designer and fabricator**

To ensure that the architect or structural engineer, on the one hand, and the metal builder or fabricator on the other hand share a common understanding of the key issues, a short checklist on the most common points of discussion has been drawn up:

- Has the stainless steel grade been specified clearly using the grade designations in EN 10088 part 1 [15]?
- Has the finish been described according to the definitions in EN 10088 part 2 [16] and have samples been agreed between the architect and the supplier?
- Is it ensured that in critical visible applications material from the same batch will be used?
- Have precautions been taken that decorative fabricated components are aligned consistently with the rolling direction?
- Does the design avoid recess areas, where dirt and moisture can accumulate?
- Has the fabricator demonstrated his experience in stainless steel in previous work?
- Does the fabricator separate carbon steel and stainless steel fabrication and does he use separate sets of hand tools?

- Is it ensured that only stainless steel fasteners are used in contact with stainless steel?
- Where bimetallic contact exists (e.g. stainless steel and carbon steel, stainless steel and aluminium...), has the risk of galvanic corrosion been excluded, e.g. by avoiding any electrically conductive contact between the partner materials?



Patterned stainless steel ensures even surfaces and efficiently masks dents

14 Fasteners

The proper installation of stainless steel fasteners is critical to the performance of the installed component. This is particularly important with respect to tightening and galling. Galling occurs when the stainless steel oxide surface film breaks down as a result of direct metal contact. Solid-phase welding can then take place (when material is transferred from one surface to another). Galling results in surface damage, and seizing and freezing up of equipment. This may occur when using stainless steel nuts and bolts together, when their contact points are subjected to high tightening torques.

Reasonable care should be exercised in the handling of fasteners to keep threads clean and free of dirt, especially coarse grime, grit or sand, and also to avoid damaging the threads. If threads are tightened down with sand or grit between them, the likelihood of galling or seizing in the fastener assembly increases significantly.

Ways to reduce galling include:

Use rolled threads

Rolled threads are less susceptible to galling than machined threads as they have a smoother surface and the grain lines follow the thread rather than cut across it, as is the case with machined threads.



Tighten to the correct torque

Overtightening increases the likelihood of galling; bolts should be tightened to the correct torque using a torque wrench.

Lubrication

Some forms of lubrication applied to threads prior to assembly can reduce the likelihood of galling. Proprietary grease-type lubricants, containing tenacious metals, oils etc are available. However, greasing bolts may result in contamination by dirt and can present problems for storage. Stainless steel screws are available with an additional zinc coating, which also has a lubricating effect.

Hardness modification

Galling can also be reduced by using dissimilar standard grades of stainless steel which vary in composition, work hardening rate and hardness (e.g. grade A2-C4, A4-C4 or A2-A4 bolt-nut combination from EN ISO 3506-1 and -2 [17]). In severe cases, a proprietary high work-hardening stainless steel alloy may be used for one component or hard surface coatings applied, e.g. nitriding or hard chromium plating. Note that if dissimilar metals or coatings are used, it is necessary to ensure that the required corrosion resistance is obtained.

Only stainless steel fasteners must be used on stainless steel panels to avoid galvanic corrosion

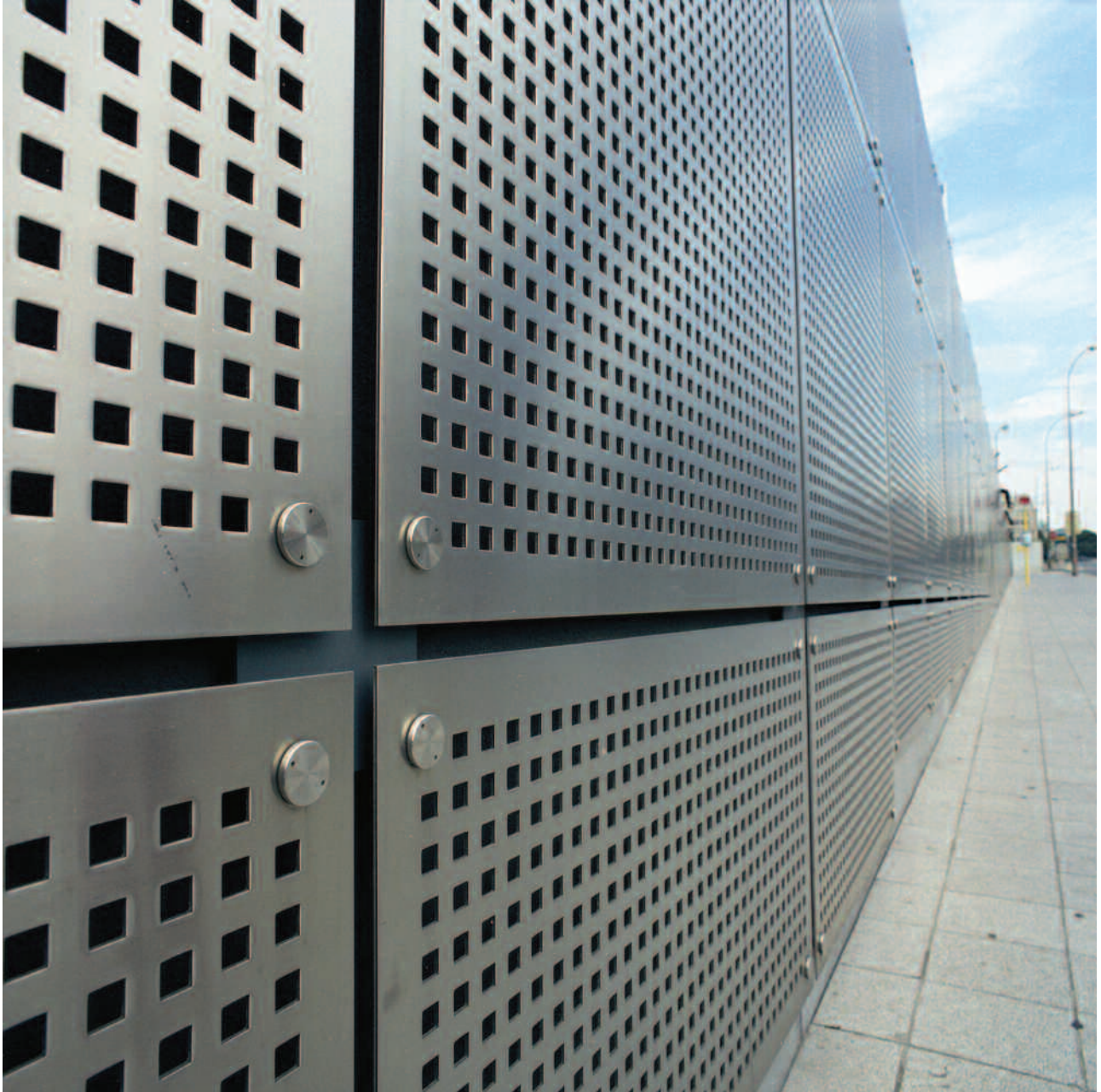

Stainless steel fasteners can be a decorative feature

15 References

- [1] CUNAT, Pierre-Jean, “Stainless Steel as a Lightweight Material for the Building Envelope”, *Proceedings of the conference Stainless Steel in Structures*, Brussels: Euro Inox, 2000; also available online at www.euro-inox.org
- [2] *Design Manual for Structural Stainless Steel, Third Edition* (Building Series, Vol. 11), Luxembourg / London: Euro Inox and The Steel Construction Institute, 2006
- [3] *prEN 1090 – 1 Steel and aluminium structural components*. General delivery conditions, September 2004.
- [4] *prEN 1090 – 2 Execution of steel structures and aluminium structures. Technical requirements for the execution of steel structures*, April 2005.
- [5] *ENV 1090 – 6, Execution of steel structures. Supplementary rules for stainless steel*, January 2000
- [6] *prEN 1991, Actions on Structures*, Part 1-6: General Actions. Actions during execution
- [7] *Tables of Technical Properties* (Materials and Applications Series, Volume 5), Luxembourg: Euro Inox 2004; also available as a searchable online data base at www.euro-inox.org
- [8] A visual demonstration of good practice is shown in the video *Stainless Steel against Corrosion*, available from Euro Inox on CD-ROM and DVD
- [9] *EN 1011-3, Welding. Recommendations for welding of metallic materials*. Arc welding of stainless steels, CEN, 2000
- [10] CUNAT, Pierre-Jean, *Welding Stainless Steel* (Materials and Applications Series, Volume 3), Luxembourg: Euro Inox 2000
- [11] *ASTM A 380, Practice for cleaning and descaling stainless steel parts, equipment and systems*, ASTM, 1994
- [12] CROOKES, Roger, *Pickling and Passivating Stainless Steel* (Materials and Applications Series, Volume 4), Luxembourg: Euro Inox 2004
- [13] *The Cleaning and Maintenance of Stainless Architectural Finishes*, Luxembourg: Euro Inox 2002
- [14] *BS PD 6484, Commentary on corrosion at bimetallic contacts and its alleviation*, British Standards Institute, 1980
- [15] *BS EN 10088-1, Stainless steels. List of stainless steels*, CEN 2005
- [16] *BS EN 10088-2, Stainless steels. Technical delivery conditions for sheet/plate and strip of corrosion resisting steel for general purposes*, CEN 2005
- [17] *EN ISO 3506, Mechanical properties of corrosion-resistant stainless-steel fasteners. Part 1: Bolts, screws and studs, Part 2: Nuts*, CEN, 1998

ISBN 2-87997-143-8